



Grandstream Networks, Inc.

UCM6510 Basic Configuration Guide



Index

Table of Contents

OVERVIEW	4
SETUP ENVIRONMENT	5
QUICK INSTALLATION.....	6
CONNECT UCM6510	6
ACCESS UCM6510 WEB INTERFACE	6
CREATE USER EXTENSION.....	8
CONFIGURE EXTENSION RANGE.....	8
BATCH & SINGLE USER CREATION	9
<i>STEPS ON ADDING SINGLE EXTENSION</i>	<i>9</i>
<i>STEPS ON ADDING BATCH OF EXTENSIONS</i>	<i>10</i>
PROVISIONING & ZERO CONFIG	13
AUTO DISCOVERING	13
EXTENSION ASSIGNMENT	14
CONFERENCE BRIDGE.....	16
HOW TO SET UP A CONFERENCE BRIDGE	16
IVR	19
CONFIGURE IVR	19
CREATE NEW IVR	19
TRUNKS.....	21
ANALOG TRUNKS	21
<i>SET UP ANALOG TRUNK.....</i>	<i>21</i>
VOIP TRUNKS.....	22
<i>SET UP VOIP TRUNK</i>	<i>23</i>
DIGITAL TRUNKS.....	25
CALL ROUTES	26
OUTBOUND ROUTES	26
<i>SET UP OUTBOUND ROUTE.....</i>	<i>26</i>
INBOUND ROUTES	28
<i>SET UP INBOUND ROUTE.....</i>	<i>28</i>

Table of Figures

Figure 1: Typical UCM6510 Connection Scenario	5
Figure 2: Connecting UCM6510	6
Figure 3: UCM6510 Web UI Login Screen	7
Figure 4: Create User Extension - Extension Range	8
Figure 5: PBX -> Basic/Call Routes -> Extensions	9
Figure 6: Create New Extension	9
Figure 7: Create New SIP Extension	10
Figure 8: Create User Extension - Created Single User	10
Figure 9: Batch Add SIP Extension	11
Figure 10: Create User Extension - Batch Add User	11
Figure 11: Create User Extension - Prompt	12
Figure 12: Create User Extension - Single and Batch Add Extensions Created	12
Figure 13: Provisioning with Zero Config - Auto Discovery	14
Figure 14: Provisioning with Zero Config - Extension Assignment	14
Figure 15: Provisioning with Zero Config - Manually Assigned Extension	15
Figure 16: Provisioning with Zero Config - Extension Status	15
Figure 17: Conference Bridge - Create New Conference Room	17
Figure 18: Conference Bridge - Create New Conference Room	17
Figure 19: Conference Bridge - Conference in Progress	18
Figure 20: IVR - Manage IVR	19
Figure 21: IVR - Create New IVR	20
Figure 22: IVR - Key Pressing Events	20
Figure 23: Analog Trunks - Create New Analog Trunk	22
Figure 24: VoIP Trunks - Create New Register SIP Trunk	24
Figure 25: VoIP Trunks - Edit VoIP Trunk	24
Figure 26: Status - Trunks	25
Figure 27: Routes – Create Outbound Route	27
Figure 28: Routes - Create Inbound Route	29

This document is subject to change without notice. The latest electronic version of this document is available for download here:

<http://www.grandstream.com/support>



Reproduction or transmittal of the entire or any part, in any form or by any means, electronic or print, for any purpose without the express written permission of Grandstream Networks, Inc. is not permitted.

OVERVIEW

This document will provide instructions on how to set up a UCM6510 from an out of the box state to a fully functional state. This includes design considerations, creating user extensions, provisioning endpoints with Zero-Config, conferencing, auto attendant configuration, analog/VoIP trunks, routing inbound/outbound calls and voicemail/fax to email setup.

For detailed information in regards to parameters that are encountered in this guide, please refer to the [UCM6510 series User Manual](#).

SETUP ENVIRONMENT

In this setup guide, we will use the UCM6510 connected into an environment as shown in the figure below. It shows a typical setup where you have the UCM6510 WAN port connected to the Internet and the LAN side of the UCM6510 providing DHCP for GXP phones as well as PCs.

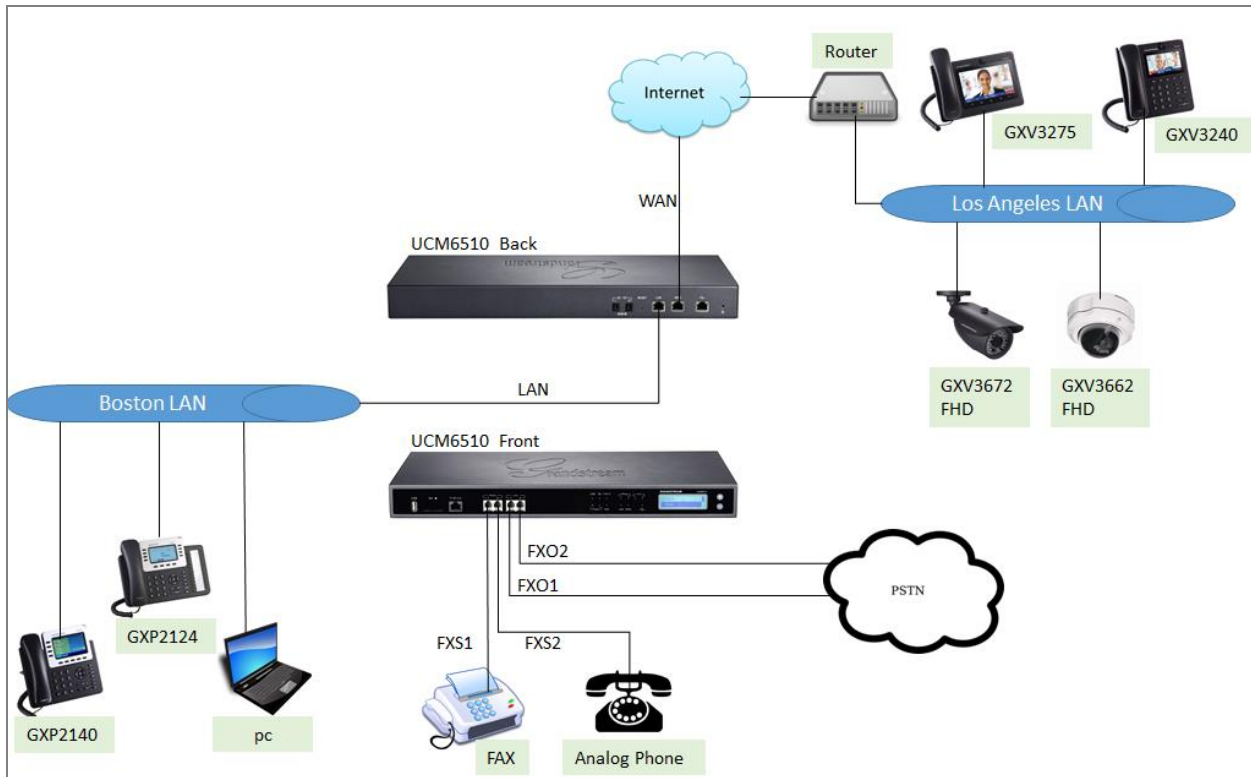

Figure 1: Typical UCM6510 Connection Scenario

For T1/E1/J1 connection, please refer to documentation here:

http://www.grandstream.com/products/ucm_series/ucm65xx/documents/how_to_configure_t1_on_ucm6510.pdf

QUICK INSTALLATION

CONNECT UCM6510

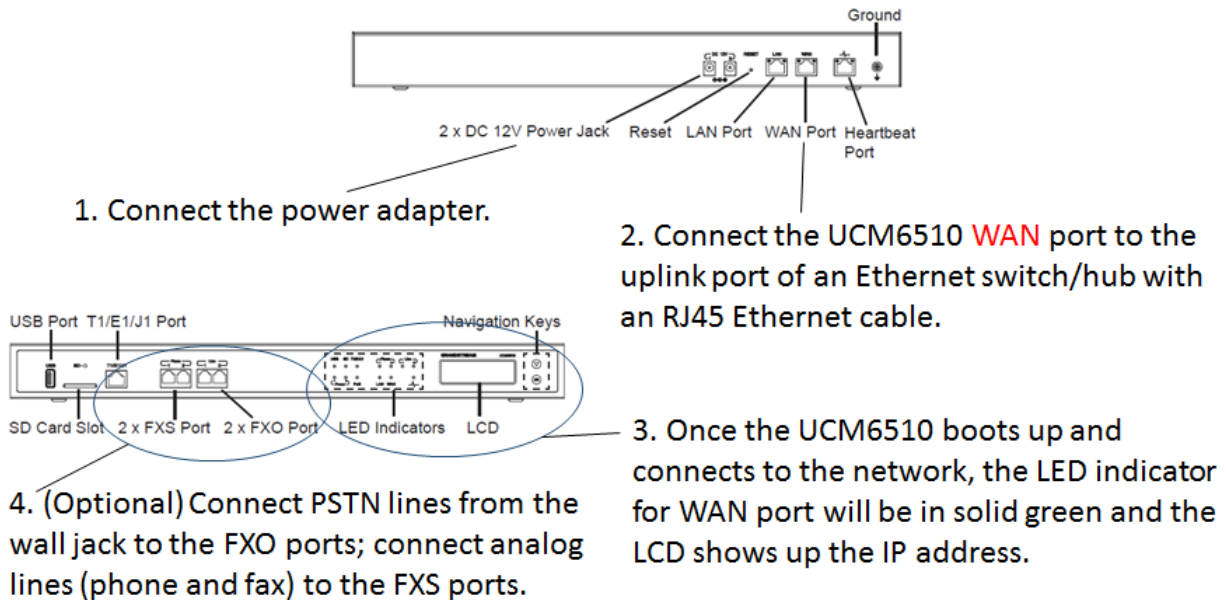

Figure 2: Connecting UCM6510

The UCM6510 will then get uplink network connection after the above installation. Users can then connect LAN port to a switch/hub which can have more IP phones and PCs to connect into, using UCM6510 as a router for the LAN network.

ACCESS UCM6510 WEB INTERFACE

Accessing the UCM6510 web interface allow users to manage users and system settings locally as well as remotely. If the computer is connected to the same switch/router that the UCM6510 WAN port is connected, then users can browse to the IP address that is displayed on the UCM6510 LCD. This address is the WAN IP. If the computer is connected to the LAN side of the UCM6510, then users would browse to the default IP of the UCM6510 which is 192.168.2.1. If successful, the UCM6510 login page will be displayed as shown below.



Figure 3: UCM6510 Web UI Login Screen

CREATE USER EXTENSION

CONFIGURE EXTENSION RANGE

First part of configuring the UCM6510 should be about planning for extension. Here are some questions to think about when setting up extension ranges:

- How many users are in the office?
- Will there be departments within the office?
- Is this office interconnecting with another office?

Once there's a clear picture of how many users will be at each location, how departments are going to be segmented and what's the expected growth of the company, a user can then configure the extension range. Navigate to web UI->**PBX->Internal Options->General**.



Extension Preference	
 Enforce Strong Password:	<input type="checkbox"/>
 Enable Random Password:	<input checked="" type="checkbox"/>
Disable Extension Range:	<input type="checkbox"/>
User Extensions:	1000 - 6299
Pick Extensions:	4000 - 4999
Auto Provision Extensions:	5000 - 6299
Conference Extensions:	6300 - 6399
Ring Group Extensions:	6400 - 6499
Queue Extensions:	6500 - 6599
Voicemail Group Extension:	6600 - 6699
IVR Extensions:	7000 - 7100
Dial By Name Extensions:	7101 - 7199
Fax Extension:	7200 - 8200

Figure 4: Create User Extension - Extension Range

In the figure above, the user extension range is set with a starting extension of 1000 and ending at 6299. This allows up to 5300 extensions to assign to users. We have also created a conference extension range from 6300 to 6399, which gives 99 conference bridges. Users can configure any extension range as they desire. Here we've configured it to use 4-digit extensions.

Click "Save" at the bottom. Then remember to click on "Apply Changes" at the top so that our extension range will be ready for the next steps.

BATCH & SINGLE USER CREATION

So now that there's extension range configured, we can begin creating users to prepare for the provisioning process. There are two methods of creating a user. One method would be creating a single user. The other method would be creating a batch of users. In this tutorial, we introduce how to create SIP extension as an example.

STEPS ON ADDING SINGLE EXTENSION

1. Navigate to **PBX->Basic/Call Routes->Extensions**. For first time setup, users will see "No Extensions defined".

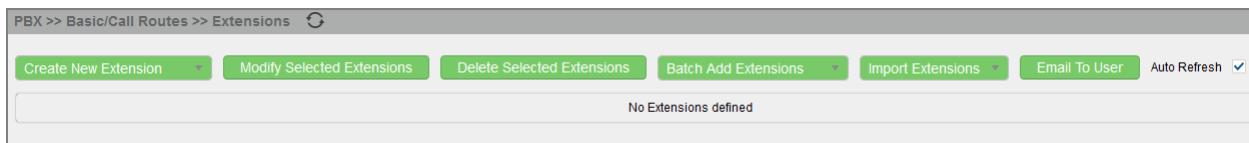

Figure 5: PBX -> Basic/Call Routes -> Extensions

2. Click on "Create New Extension" and the select "Create New SIP Extension" from the drop down list.

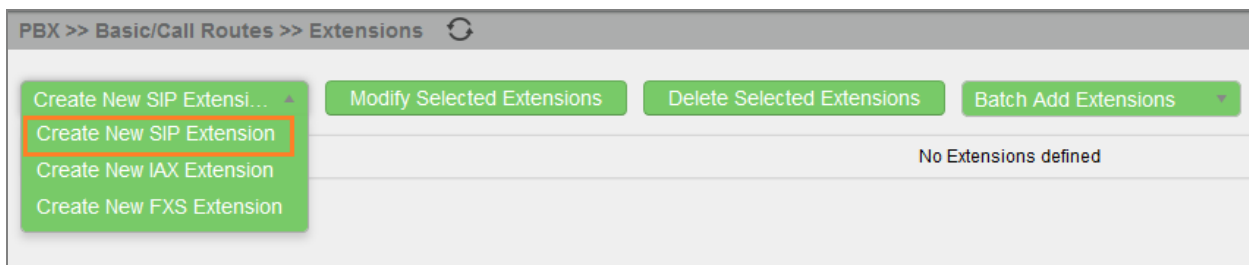

Figure 6: Create New Extension

3. On the "Create New SIP Extension" dialog, users can enter in quite a few options, but they are not required for this tutorial. Click "Save" at the bottom of the page.

Create New SIP Extension

General



<input type="text" value="1000"/>	<input type="text"/>
<input type="text" value="Internal"/>	<input type="text" value="c#liG7"/>
<input checked="" type="checkbox"/>	<input type="text" value="041706"/>
<input type="text"/>	<input type="text"/>
<input type="text"/>	<input type="text"/>
<input type="checkbox"/>	<input type="checkbox"/>
<input type="checkbox"/>	

User Settings

<input type="text" value="Jane"/>	<input type="text" value="Tan"/>
<input type="text" value="support@grandstream.com"/>	<input type="text" value="Default"/>

Figure 7: Create New SIP Extension

- After clicking “Save” the Extensions page will display with the single SIP extension that was just created. Here the user has the ability to edit the extensions by clicking on  at the right.

Status	Extension	CallerID Name	Technology	IP and Port	Options
☐	1000	Jane Tan	SIP	--	  

Total: 1 Show: 1/1 Go to:

Figure 8: Create User Extension - Created Single User

STEPS ON ADDING BATCH OF EXTENSIONS

- Navigate to **PBX->Basic/Call Routes->Extensions**
- Click on “Batch Add Extensions” and then select “Batch Add SIP Extension” from the drop down list.

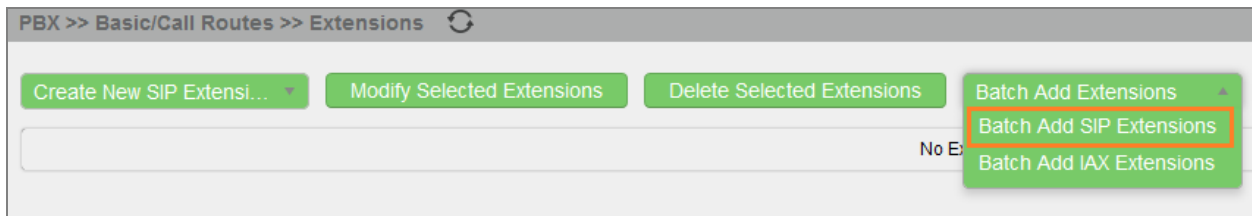
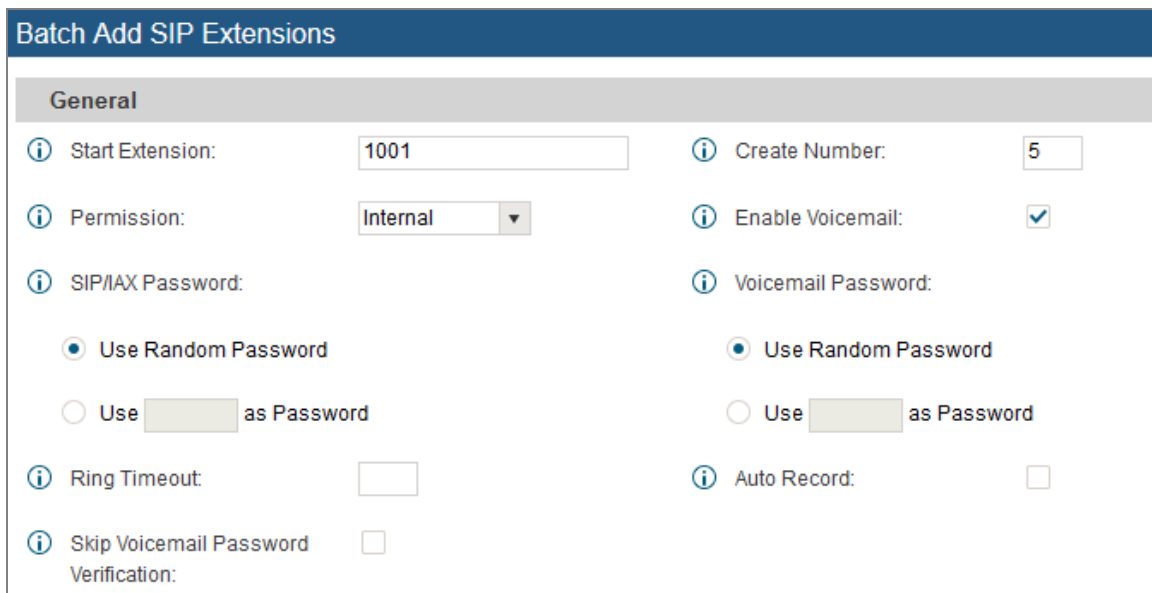

Figure 9: Batch Add SIP Extension

- At the “Batch Add Extensions” dialog, the user can specify the “Starting Extension” and the number of extensions to generate by setting the “Create Number”. In this tutorial we will have a starting extension of 1001 and have the UCM6510 generate 5 extensions with a password randomly generated. This would create extensions 1001, 1002, 1003, 1004 and 1005.



The screenshot shows the 'Batch Add SIP Extensions' dialog box. The 'General' tab is selected. The form contains the following fields and options:

- Start Extension:** Text input field containing '1001'.
- Create Number:** Text input field containing '5'.
- Permission:** Dropdown menu set to 'Internal'.
- Enable Voicemail:** Checkmark is checked.
- SIP/IAX Password:** Radio button selected for 'Use Random Password'.
- Voicemail Password:** Radio button selected for 'Use Random Password'.
- Ring Timeout:** Text input field.
- Auto Record:** Checkmark is unchecked.
- Skip Voicemail Password Verification:** Checkmark is unchecked.

Figure 10: Create User Extension - Batch Add User

- Click “Create Users” at the bottom to have the UCM6510 generate the extensions
- Next, a prompt will appear asking “Are you sure you want to create users: 1001, 1002, 1003, 1004 1005”. Click on “OK”.

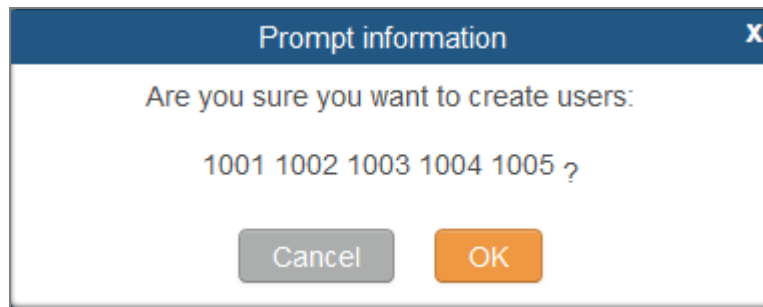

Figure 11: Create User Extension - Prompt

At this point the Extensions page should look similar to this:

PBX >> Basic/Call Routes >> Extensions

Auto Refresh

Status	Extension	CallerID Name	Technology	IP and Port	Options
<input type="checkbox"/>	1000	Jane Tan	SIP	--	
<input type="checkbox"/>	1001	--	SIP	--	
<input type="checkbox"/>	1002	--	SIP	--	
<input type="checkbox"/>	1003	--	SIP	--	
<input type="checkbox"/>	1004	--	SIP	--	
<input type="checkbox"/>	1005	--	SIP	--	

Total: 6 Show: 1/1 Go to:

Figure 12: Create User Extension - Single and Batch Add Extensions Created

PROVISIONING & ZERO CONFIG

Grandstream SIP Devices can be configured via Web interface as well as via configuration file through TFTP/HTTP/HTTPS download. All Grandstream SIP devices support a proprietary binary format configuration file and XML format configuration file. The UCM6510 provides a Plug and Play mechanism to auto-provision the Grandstream SIP devices in a zero configuration manner by generating XML config file and having the phone to download it. This allows users to finish the installation with ease and start using the SIP devices in a managed way.

To provision a phone, three steps are involved, i.e., discovery, assignment and provisioning. The UCM6510 creates XML config file to the detected/assigned Grandstream device and accomplishes the following configurations on the device after the provisioning:

- A UCM6510 extension will be assigned and registered on the phone.
- SIP-related network settings such as "NAT traversal" and "Use Random Port" are configured on the phone.
- Call settings such as "Dial Plan" and "Auto Answer".
- LDAP client configurations will be set up automatically on the phone to use the default LDAP directory generated in the UCM6510 LDAP server.

This section explains how zero config works on the UCM6510. The settings for this feature can be accessed via Web GUI->**PBX->Basic/Call Routes->Zero Config**.

AUTO DISCOVERING

When referring back to our typical scenario in the beginning of this tutorial, we know that there is a GXP2124 connected to the LAN side of the UCM6510. The UCM6510 LAN interface has DHCP enabled and has assigned the GXP2124 with an IP address. By default the IP assigned would be within the 192.168.2.X range. When the UCM6510 offers an IP address to the phone it also offers DHCP Option 66, which provides the phone with a config server path that points to the UCM6510. All of Grandstream VoIP devices have Option 66 turned on by default and this is how the GXP2124 was discovered by the UCM6510.

Upon being discovered, the GXP2124 will provide details about its MAC, IP Address, Version (Firmware), Vendor, Model, Connection Status and Create Config.

By navigating to **PBX->Basic/Call Routes->Zero Config**, a user will be able to see the discovered device(s).



Auto Provision Settings Auto Discover Create New Device Delete Selected Devices Reset All Extensions									
Filter: <input type="text" value="All"/>									
No.	MAC Address	IP Address	Extension	Version	Vendor	Model	Connection Status	Create Config	Options
1.	000B82565E1E	192.168.2.101		1.0.5.26	Grandstream	GXP2124	Connected	No	  

Figure 13: Provisioning with Zero Config - Auto Discovery

EXTENSION ASSIGNMENT

In the Auto Provision settings, users have the option to enable “Automatically Assign Extension”. If enabled, an extension will be created and assigned to the new device detected. This is a great feature if specific extension assignment isn’t required, but for our setup we’ll work on manually assigning an extension to a discovered device.

Navigate to **PBX->Basic/Call Routes->Zero Config** and click on  for the discovered device.

The next screen provides details of the device and also allows a user to assign an extension. Since the GXP2124 is a 4 line phone, the UCM6510 gives us the option to assign 4 extensions to the phone.

Edit Device : 000b823ab2f0 x

MAC Address:

IP Address:

Version:

Model:

Account Select: Account 1:

Figure 14: Provisioning with Zero Config - Extension Assignment

Click on the Account 1 and select the desired extension, then click “Save”. Now the Zero Config page displays the device with an extension assigned to it on Account 1.

MAC Address	IP Address	Extension	Version	Vendor	Model	Connection Status	Create Config	Options
000B823AB2F0	192.168.2.101	Account 1-1000	1.0.5.58	Grandstream	GXP2124	Connected	No	  

Figure 15: Provisioning with Zero Config - Manually Assigned Extension

After assigning an extension, the phone must be rebooted in order to pick up the configuration file from the UCM6510. During this process, the phone will boot up, request for config file, download the config file, then reboot once more in order to apply the changes.

After the phone is completely booted, navigate to **PBX->Basic/Call Routes->Extensions** page to see the extension status. The SIP status will show a green circle for a successful registration.





Status	Extension	CallerID Name	Technology	IP and Port	Options
	1000	Jane Tan	SIP	192.168.2.101:5062	  

Figure 16: Provisioning with Zero Config - Extension Status

CONFERENCE BRIDGE

The UCM6510 supports up to 8 conference bridges allowing up to 64 simultaneous PSTN or IP participants.

The conference bridge configurations can be accessed under Web GUI->**PBX->Call Features->Conference**. In this page, users could create, edit, view, invite, manage the participants and delete conference bridges. The conference bridge status and conference call recordings (if recording is enabled) will be displayed in this web page as well.

HOW TO SET UP A CONFERENCE BRIDGE

1. Click on “Create New Conference Room”
2. On the “Create New Conference Room” dialog, the Extension is automatically populated since the extension range is in effect. Users can assign another number that is within the Conference Extension range
3. Next, uncheck the option “Public Mode”. This will make the password options available. Enter a numeric password for an admin as well as the regular user password. In this example, the user enters 511511 as the user password and 510510 as the admin password.

Create New Conference Bridge
X

i Extension:

Password Options

i Password:

i Admin Password:

Conference Room Options

i Enable Caller Menu:

i Record Conference:

i Quiet Mode:

i Wait For Admin:

i Enable User Invite:

i Announce Callers:

i Public Mode:

i Play Hold Music:

i Skip Authentication When Inviting Users via Trunk from Web GUI:

Cancel
Save

Figure 17: Conference Bridge - Create New Conference Room

4. Click “Save” at the bottom then “Apply Changes” at the top.





We should now have a conference room created and the status page will display the following:

Room	Attend	Admin	Start Time	Activity	Options
▼ 6300	0	0			

Figure 18: Conference Bridge - Create New Conference Room

With the phone that was registered to the UCM6510, dial the conference room extension. For this example we will dial 6300. The user will hear a prompt for the conference password. Depending on the user, the regular password or admin password can be entered.

During a conference call, the admin can login to the UCM6510 web GUI and view the conference room status. This provides the admin with details on which conference room is active, who the participants are and the conference call current duration.

Besides status information, the admin has a several conference management tools. By clicking the  button, the admin can invite other users to the conference. Clicking  will kick the selected user from the conference. When clicking  or  button the admin will mute/unmute the specific user.









Room	Attend	Admin	Start Time	Activity	Options
6300	1	0	2014-10-17 20:52:11	00:00:27	   
User	Caller ID	Caller Name	Channel Name	Activity	Options
 1	1000	Jane Tan	SIP/1000-00000000	00:00:27	 

Figure 19: Conference Bridge - Conference in Progress

IVR





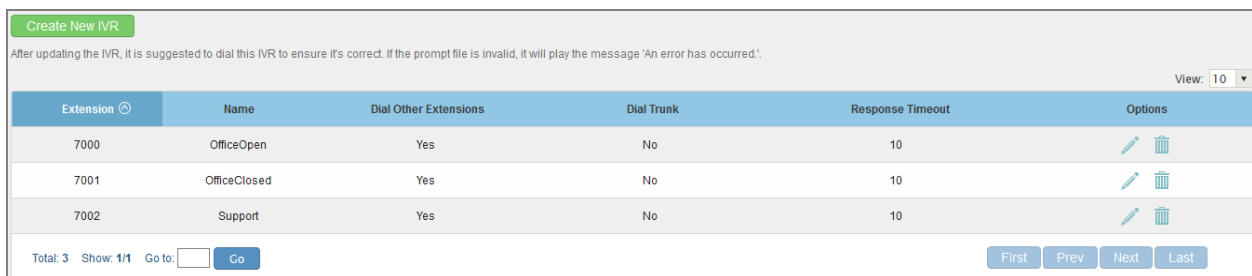

CONFIGURE IVR

IVR configurations can be accessed under the UCM6510 Web GUI->**PBX->Call Features->IVR**. Users could create, edit, view and delete an IVR.

- Click on "Create New IVR" to add a new IVR.
- Click on  to edit the IVR configuration.
- Click on  to delete the IVR.



The screenshot shows the 'Manage IVR' interface. At the top left is a green 'Create New IVR' button. Below it is a note: 'After updating the IVR, it is suggested to dial this IVR to ensure it's correct. If the prompt file is invalid, it will play the message 'An error has occurred.''. On the right, there is a 'View: 10' dropdown. The main area contains a table with the following data:

Extension	Name	Dial Other Extensions	Dial Trunk	Response Timeout	Options
7000	OfficeOpen	Yes	No	10	 
7001	OfficeClosed	Yes	No	10	 
7002	Support	Yes	No	10	 

At the bottom left, there is a summary: 'Total: 3 Show: 1/1 Go to: Go'. At the bottom right, there are navigation buttons: 'First', 'Prev', 'Next', 'Last'.

Figure 20: IVR - Manage IVR

CREATE NEW IVR

1. Click on "Create New IVR"
2. Enter a Name for the IVR. This is used for referencing purposes. In this example the user will create "OfficeHours2"
3. "Extension" is populated automatically by the extension range that was created in the beginning of the tutorial. A user may choose another IVR extension within the range if desired.
4. Enable "Dial Other Extensions" to allow callers who reach the IVR to dial a direct internal extension without having to go through voice prompts.
5. "Welcome Prompt" is the recording that will be played when a caller reaches the IVR. Users can click on the "Prompt" link next to the dropdown box to configure a welcome prompt.

Create New IVR

Name:	<input type="text" value="OfficeHours2"/>
Extension:	<input type="text" value="7004"/>
Dial Other Extensions:	<input checked="" type="checkbox"/>
Dial Trunk:	<input type="checkbox"/>
Permission:	<input type="text" value="Internal"/>
Welcome Prompt:	<input type="text" value="welcome"/> Prompt
Digit Timeout:	<input type="text" value="3"/>
Response Timeout:	<input type="text" value="10"/>
Response Timeout Prompt:	<input type="text" value="ivr-create-timeout"/>
Invalid Prompt:	<input type="text" value="invalid"/>
Response Timeout Repeat Loops:	<input type="text" value="3"/>
Invalid Repeat Loops:	<input type="text" value="3"/>
Language:	<input type="text" value="Default"/>

Figure 21: IVR - Create New IVR

6. The next section on configuring an IVR would be the Key Pressing Events. Users can direct calls based on a callers selection. For example, a caller reaches the IVR and the Welcome Prompt plays, “Thank you for calling Grandstream Networks. For support, please dial 0. For Sales, please dial 1.” Click on the drop down box for the first event, which is “Press 0” and select Extension. Another drop down box will appear and the user can then select an extension from the list. For this example, the user selects Extension 1000.
7. For Key Pressing Event “Press 1” click on the drop down box and select Extension. User selects Extension 101. Besides from Extension as a Key Pressing Event, the user can select Voicemail, Conference Room, Voicemail Group, IVR, Ring Group and many more.

Key Pressing Events

Press 0:	<input type="text" value="Extension"/>	<input type="text" value="1000"/>
Press 1:	<input type="text" value="Extension"/>	<input type="text" value="1001"/>
Press 2:	<input type="text" value="Select an Option"/>	



Figure 22: IVR - Key Pressing Events

8. Click “Save” at the bottom and then click on “Apply Changes” at the top.

TRUNKS

ANALOG TRUNKS

Go to Web GUI->**PBX->Basic/Call Routes->Analog Trunks** to add and edit analog trunks.

- Click on "Create New Analog Trunk" to add a new analog trunk
- Click on  to edit the analog trunk
- Click on  to delete the analog trunk

The UCM6510 has built-in FXO ports which allows it to pull in PSTN lines and provide analog trunk service. For this example, we will configure an analog line that is connected to FXO1.

SET UP ANALOG TRUNK

1. Click on "Create New Analog Trunk".
2. For "Channels" select 1.
3. Trunk Name is set to "Analog1".
4. "Caller ID Scheme" is set for "Bellcore/Telcordia". Depending on the provider, users can select other schemes.
5. "Tone Country" is set to "United States of America (USA)" since this tutorial is setup in the North American region. Users can click the dropdown box to select an option more suited for their region.
6. Click "Save" and then click on "Apply Changes" at the top.

Create New Analog Trunk
X

Channels: 1 2

Trunk Name:

Advanced Options

Enable Polarity Reversal:

Current Disconnect Threshold(ms): 200 Ring Timeout:

RX Gain: TX Gain:

Use CallerID: Fax Detection:

Caller ID Scheme:

FXO Dial Delay(ms):

Auto Record:

Tone Settings

Busy Detection: Busy Tone Count:

Congestion Detection: Congestion Count:

Tone Country:

Busy Tone:

Congestion Tone:

PSTN Detection:





Figure 23: Analog Trunks - Create New Analog Trunk

Note: If there are reports of calls being dropped and lines are not disconnecting properly, this could mean that there are line settings mismatched. The UCM6510 offers an auto detect feature that tests the line and provides the best possible settings. This option is called “PSTN Detection” which can be found under the Analog trunk configuration page.

VOIP TRUNKS

VoIP trunks can be configured under Web GUI->**PBX->Basic/Call Routes->VoIP Trunks**. Once created, the VoIP trunks will be listed with Provider Name, Type, Hostname/IP, Username and Options to edit/detect the trunk.

- Click on "Create New SIP Trunk" to add a new VoIP SIP trunk

- Click on  to configure detailed parameters for the VoIP SIP trunk
- Click on  to configure Direct Outward Dialing (DOD) for the SIP Trunk
- Click on  to start LDAP Sync
- Click on  to delete the VoIP trunk

There are 4 different types of VoIP trunks that can be configured:

- Peer SIP Trunk
- Register SIP Trunk
- Peer IAX Trunk
- Register IAX Trunk.

This tutorial will demonstrate how to configure a SIP Registered Trunk.

SET UP VOIP TRUNK

1. Click on “Create New SIP Trunk”.
2. Click the dropdown box for Type and select “Register SIP Trunk”.
3. Enter a name for “Provider Name” e.g., GSTrunk.
4. Configure the IP address or URL of the VoIP providers server as the “Host Name” e.g., sip.grandstream.com.
5. Input the username to authenticate with the VoIP provider as the “Username” e.g, 6266389172.
6. Enter password for username to authenticate with VoIP provider server.
7. Enter the AuthID. This is the SIP service subscriber’s ID used for authentication. If not configured, the CallerID will be used for authentication.
8. Enter an outbound proxy if the provider requires one.
9. Click “Save” and then “Apply Changes” at the top.

Create New SIP Trunk

More details will be shown when editing trunk.

Type: Register SIP Trunk ▼

(i) Provider Name: GStrunk

(i) Host Name: sip.grandstream.com

(i) Keep Trunk CID:

(i) Username: 6266389172

 Password: ••••••

(i) AuthID: 6266389172

(i) Outbound Proxy:

(i) Auto Record: No ▼

Cancel
Save

Figure 24: VoIP Trunks - Create New Register SIP Trunk

After creating the SIP trunk, users can click the  on the right of the VoIP trunk for more configuration options.

(i) Codec Preference:

	Available Codecs		Selected Codecs	
	ILBC	▲	PCMU	▲
	G.722	▼	PCMA	▼
	AAL2-G.726-32	↺	GSM	↺
	ADPCM	↻	G.726	↻
	G.723	▼	G.729	▼

(i) From Domain:

(i) From User:

(i) Outbound Proxy Support:

(i) Auto Record: No ▼

(i) DID Mode: Request-line ▼

(i) Enable Qualify:

(i) Fax Detection:

(i) SRTP:

Figure 25: VoIP Trunks - Edit VoIP Trunk

To verify if the SIP trunk is registered, the user may navigate to Web UI->**Status** to check the trunk status.

Trunks 				
Status	Trunks	Type	Username	Port/Hostname/IP
Registered	Cl_Gear2	SIP	12896679999	sip.ringoffice.com
Unregistered	GSTrunk	SIP	6266389172	sip.grandstream.com
Unavailable	Analog1	Analog		Ports 1

Figure 26: Status - Trunks

DIGITAL TRUNKS

Please refer to sample T1 trunk configuration in the document here:







http://www.grandstream.com/products/ucm_series/ucm65xx/documents/how_to_configure_t1_on_ucm6510.pdf

CALL ROUTES

OUTBOUND ROUTES

In the UCM6510, an outgoing calling rule pairs an extension pattern with a trunk used to dial the pattern. This allows different patterns to be dialed through different trunks (e.g., "Local" 7-digit dials through a FXO while "Long distance" 10-digit dials through a low-cost SIP trunk). Users can also set up a failover trunk to be used when the primary trunk fails.

Go to Web GUI->**PBX->Basic/Call Routes->Outbound Routes** to add and edit outbound rules.

- Click on "Create New Outbound Rule" to add a new outbound route
- Click on  to edit the outbound route
- Click on  to delete the outbound route
- On the UCM6510, the outbound route priority is based on "Best matching pattern". For example, the UCM6510 has outbound route A with pattern 1xxx and outbound route B with pattern 10xx configured. When dialing 1000 for outbound call, outbound route B will always be used first. This is because pattern 10xx is a better match than pattern 1xxx. Only when there are multiple outbound routes with the same pattern configured, users can click on     to move the outbound route up/down to arrange the priority among those outbound routes.

SET UP OUTBOUND ROUTE

1. Click "Create New Outbound Rule".
2. Configure the name of the Calling Rule. For example, 'Local', 'LongDistance' and etc.
3. Create a dial pattern.
For 7 digit dialing (Local) the pattern will look like this: XXXXXXX. This means that any 7 digits will use this route. For 10 digit dialing the pattern would look like this: NXXNXXXXXX. If a '1' is required before dialing out, the dial patter can be configured in this manner: 1NXXNXXXXXX.

In this example, the dial pattern is going to be created for local 7 digit dialing so the pattern is XXXXXXX.

- Next, set a “Privilege Level”. There are 4 Privilege Levels; Internal, Local, National, International. Internal is the lowest level of security whereas international is the highest level of security.

The way that Privilege Levels are used could be thought of as door locks. Extensions are granted with “Permissions” that can be seen as keys. If an Extension is configured with an Internal permission, it CANNOT access an outbound route with a Privilege level of Local, National and International. A user configured with National permission can access routes that have a Privilege Level of Internal, Local, National, but not International.

- The pattern that was configured is a 7 digit dialing pattern. For “Use Trunk” select the Analog Trunk or select the desired trunk for this particular dial pattern. For long distance calls, it may be cost effective to route the calls to SIP trunk versus going through a local PSTN line.
- Click “Save” and then click on “Apply Changes” at the top.

Create New Outbound Rule
X

ⓘ Calling Rule Name:

ⓘ Pattern: +

ⓘ Password:

ⓘ Privilege Level: International ▼

ⓘ Enable Filter on Source Caller ID:

Send this call through trunk

ⓘ Use Trunk: Analog Trunks -- fx01 ▼

ⓘ Strip:

ⓘ Prepend:

ⓘ Use Failover Trunk:



Trunks	Strip	Prepend	Options
Click to add failover trunk			

Figure 27: Routes – Create Outbound Route

INBOUND ROUTES

In the UCM6510, an incoming calling rule allows for various inbound destinations. Users can route inbound calls by DID, to Extension, Voicemail, Conference Room, Queue, Ring Group, Page, Voicemail Group, FAX, DISA or IVR. These inbound routes can also be triggered based on a time condition as well.

Inbound routes can be configured via Web GUI->**PBX->Basic/Call Routes->Inbound Routes**.

- Click on "Create New Inbound Rule" to add a new inbound route
- Click on "DID Features" to configure DID features for the inbound route
- Click on "Blacklist" to configure blacklist for all inbound routes
- Click on  to edit the inbound route
- Click on  to delete the inbound route

This section of the tutorial will provide instructions on how to setup an inbound route for a Registered SIP Trunk. Inbound calls into this SIP trunk will have a default destination as well as a time conditioned destination.

SET UP INBOUND ROUTE

1. Click on "Create New Inbound Rule".
2. For "Trunks" select the SIP trunk that has been configured. (e.g. GS Trunk).
3. The DID pattern can be composed of two parts, divided by a '/' character. The first part is used to specify the dialed number and the second part is used to specify the caller ID, which is optional. If caller ID section is entered it means only the extension with the specific caller ID is allowed to call into this trunk.
4. "Privilege level" can be left as Internal.
5. Click the dropdown box for "Default Destination" and select IVR. Then select the IVR extension.
6. Next, click on "Click to add Time Condition".
7. Enter a "Start Time" of 8am, "End Time" of 6pm.
8. Next select By Week for "Date" and select Monday-Friday.

9. For “Destination” select Extension and choose an extension number.

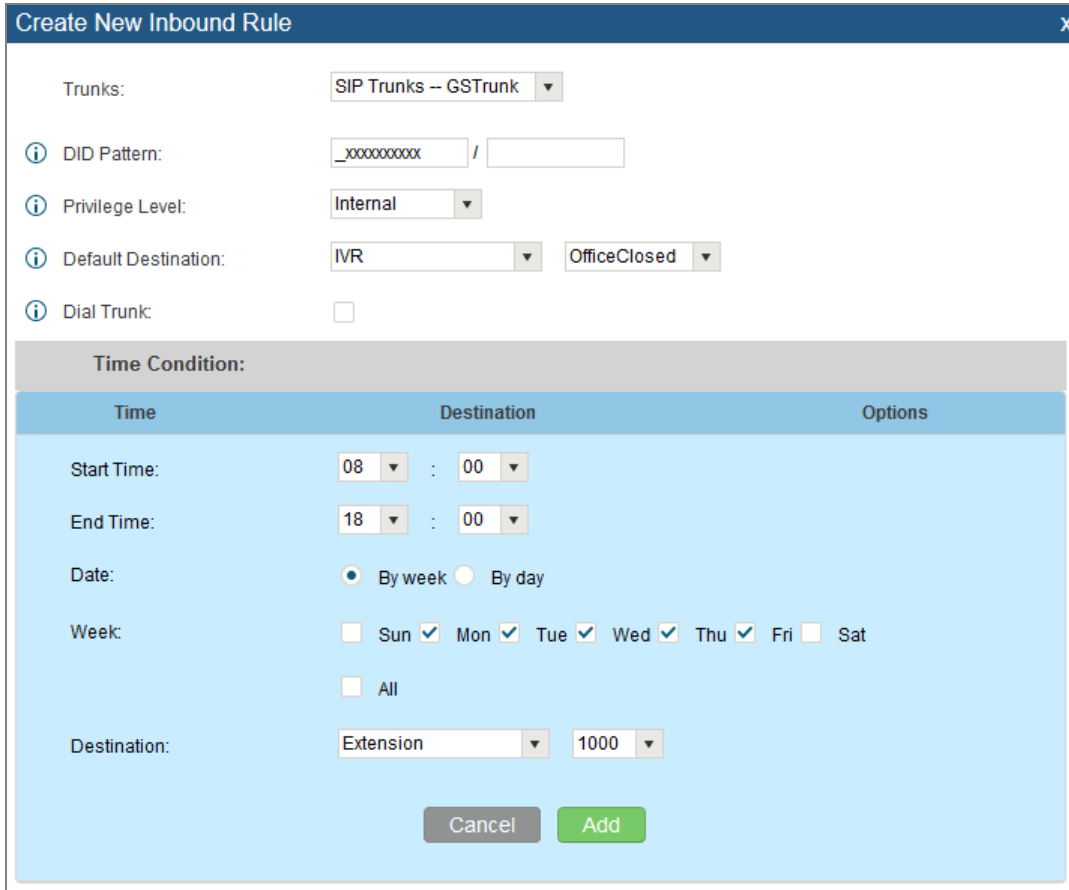

Create New Inbound Rule

Trunks: SIP Trunks -- GSTrunk

DID Pattern: _xxxxxxxx /

Privilege Level: Internal

Default Destination: IVR OfficeClosed

Dial Trunk:

Time Condition:

Time	Destination	Options
Start Time: 08 : 00		
End Time: 18 : 00		
Date: <input checked="" type="radio"/> By week <input type="radio"/> By day		
Week: <input type="checkbox"/> Sun <input checked="" type="checkbox"/> Mon <input checked="" type="checkbox"/> Tue <input checked="" type="checkbox"/> Wed <input checked="" type="checkbox"/> Thu <input checked="" type="checkbox"/> Fri <input type="checkbox"/> Sat		
<input type="checkbox"/> All		
Destination: Extension	1000	

Cancel Add

Figure 28: Routes - Create Inbound Route

When a call is received on this SIP trunk during the hours of 8am to 6pm from Monday to Friday it will be routed to extension 1000. All calls outside of this condition will be routed to the IVR “OfficeClosed”.

If there are any questions or concerns, please feel free to get in contact with Grandstream Networks support by calling (617) 566-9300 or create a support ticket by clicking this [link](#).

*** Asterisk is a Registered Trademark of Digium, Inc.**