



Grandstream Networks, Inc.

How to Configure T1 Trunk on UCM6510



Index

Table of Contents

OVERVIEW	3
1. CONNECTING T1 PORT.....	4
2. CONFIGURING T1 CHANNELS.....	5
3. CONFIGURING DIGITAL PORT.....	8
4. CONFIGURING DIGITAL TRUNK.....	10
5. CONFIGURING DATA TRUNK.....	12
6. MONITORING DIGITAL PORT AND DIGITAL CHANNEL STATUS.....	14

Table of Figures

Figure 1: Sample T1 Topology Using UCM6510.....	3
Figure 2: UCM6510 Front View.....	4
Figure 3: T1 Crossover Cable Pin-out.....	4
Figure 4: Configure Digital Hardware Span Type 1.....	5
Figure 5: Configure Digital Hardware Span Type 2.....	5
Figure 6: Configure Default Group 1.....	5
Figure 7: Configure Default Group 2.....	6
Figure 8: Add New Group 1.....	6
Figure 9: Add New Group 2.....	7
Figure 10: Configure Digital Port 1.....	8
Figure 11: Configure Digital Port – Basic Settings.....	8
Figure 12: Configure Digital Port – Advanced Settings.....	9
Figure 13: Create New Digital Trunk.....	10
Figure 14: Configure Digital Trunk.....	10
Figure 15: Digital Trunk Status.....	11
Figure 16: PBX->Basic/Call Routes->Data Trunk.....	12
Figure 17: Configure Data Trunk.....	12
Figure 18: Data Trunk Status.....	13
Figure 19: Interface Status.....	14
Figure 20: Digital Channels Status.....	15
Figure 21: Data Trunk Status.....	16

This document is subject to change without notice. The latest electronic version of this document is available for download here:

<http://www.grandstream.com/support>

Reproduction or transmittal of the entire or any part, in any form or by any means, electronic or print, for any purpose without the express written permission of Grandstream Networks, Inc. is not permitted.

OVERVIEW

The UCM6510 supports T1/E1/J1 digital trunk and data trunk. Digital trunk allows voice transmission in digital signal while data trunk is used for data transmission so that the device can connect to the Internet. On the UCM6510, the system administrator can configure both trunks allowing voice and data transmission at the same time by specifying the channels. This document presents a configuration sample to introduce how to set up T1 trunk on the UCM6510.

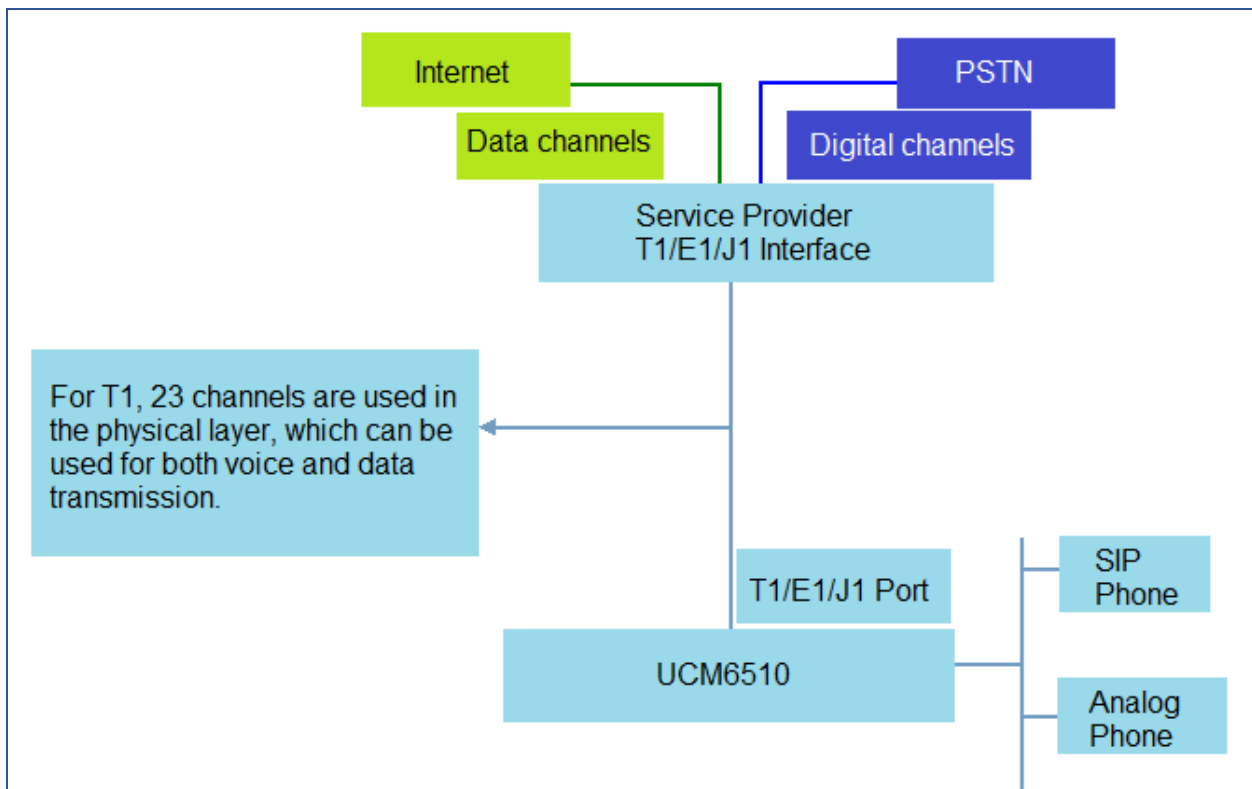

Figure 1: Sample T1 Topology Using UCM6510

For more information about how to configure UCM6510, please refer to the UCM6510 user manual in www.grandstream.com/support.

1. CONNECTING T1 PORT

The following figure shows the UCM6510 front view where you can see the T1/E1/J1 port.

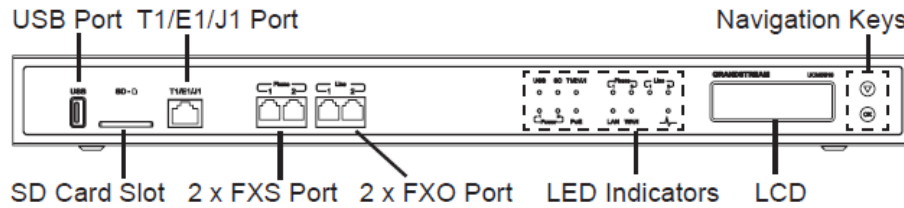

Figure 2: UCM6510 Front View

Use a T1 crossover cable to plug one end into the UCM6510 T1/E1/J1 port. Plug the other end into the T1/E1/J1 walljack. Please check if the T1 crossover cable can be provided from the service provider. The proper T1 crossover cable pin-out is shown in the following figure.

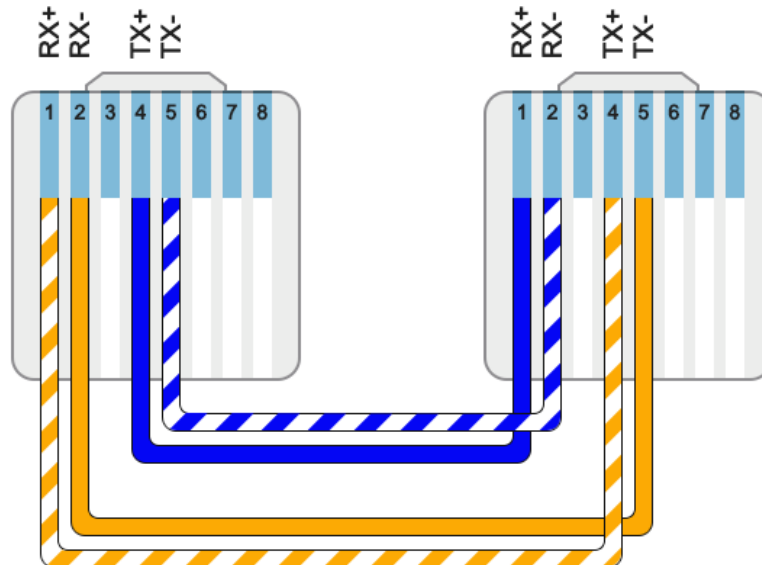

Figure 3: T1 Crossover Cable Pin-out

2. CONFIGURING T1 CHANNELS

2.1. Go to UCM6510 web UI->**PBX->Ports Config->Digital Hardware** page. Click on  to configure the digital hardware type.

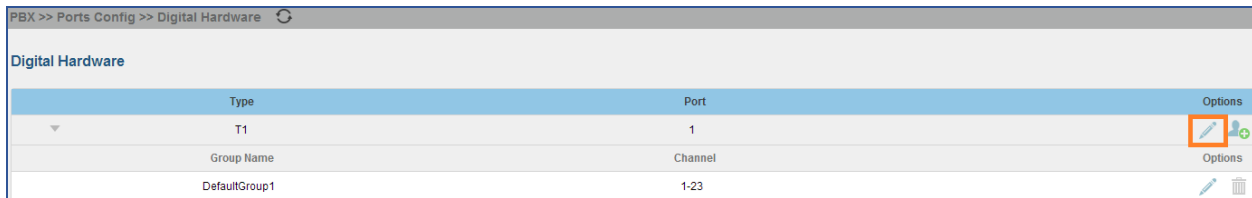

Figure 4: Configure Digital Hardware Span Type 1

2.2. Select Span Type “T1”. And click on “Update” on the bottom of the dialog.

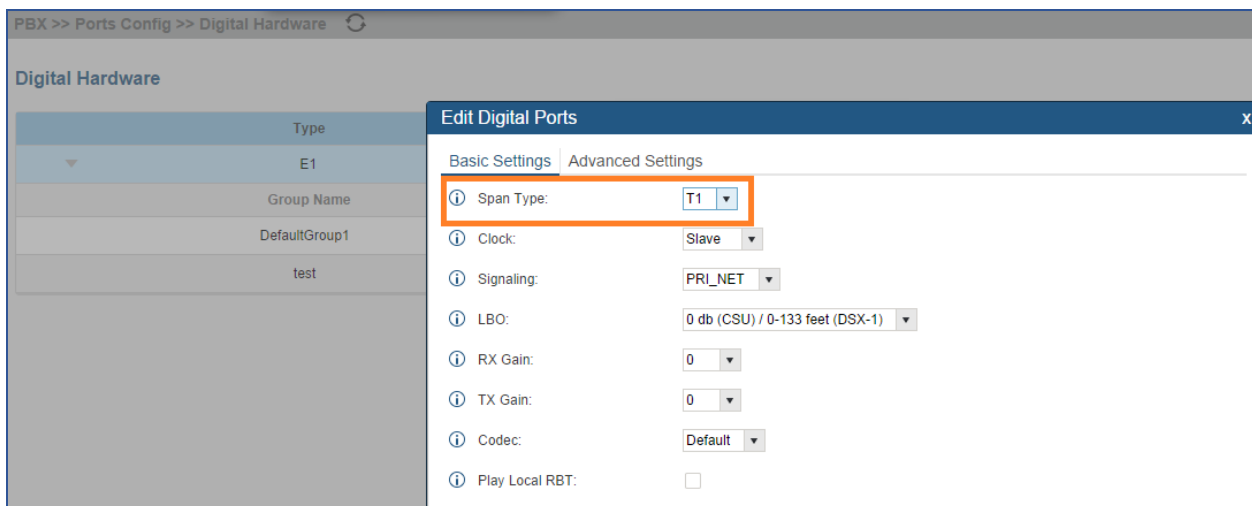

Figure 5: Configure Digital Hardware Span Type 2

2.3. Go to UCM6510 web UI->**PBX->Ports Config->Digital Hardware** page. Click on  to edit the default group.

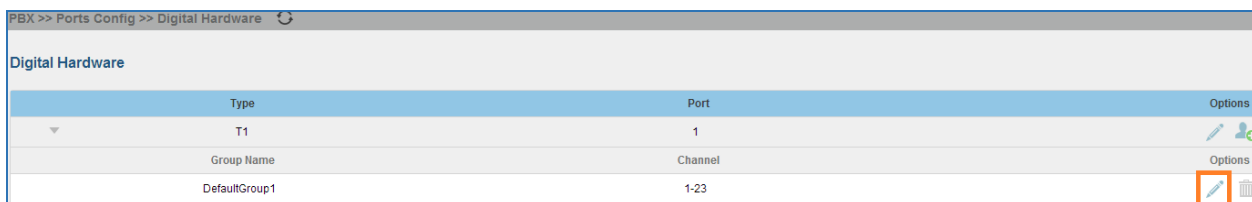

Figure 6: Configure Default Group 1

This is necessary because the default setting in default group has all the channels included. We need modify default group to make sure the number of used channels is within the max number of channels allowed for T1, E1 or J1.

For D channel, channel 16 is always used in E1 and channel 24 is always used in T1/J1.

In this example, we configured channel 1-10 in default group (for voice).

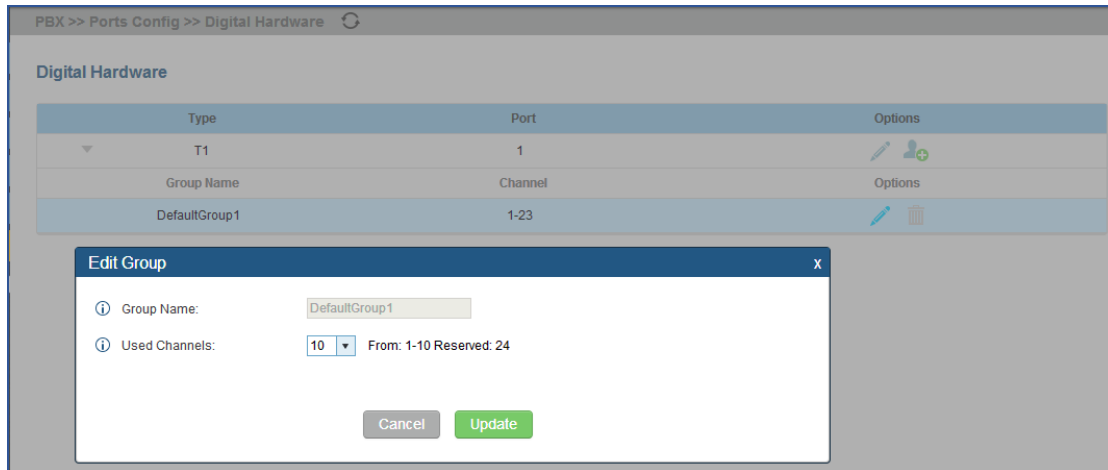

Figure 7: Configure Default Group 2

2.4. Click on “Update” to save the setting.

2.5. In web UI->**PBX->Ports Config->Digital Hardware** page, click on  to add a new group.

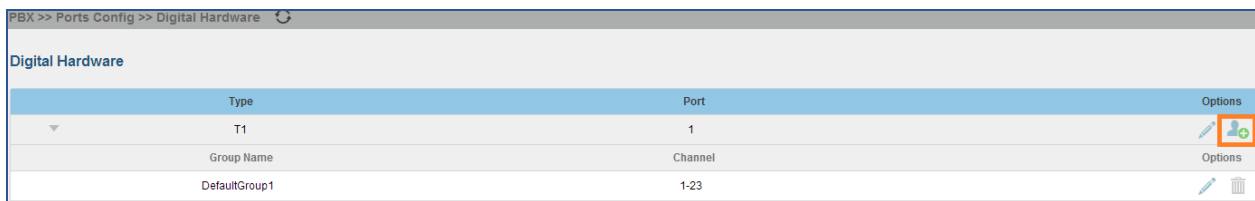

Figure 8: Add New Group 1

As long as there are available channels, users will be able to create new group and assign channels.

2.6. Assign channels for the new group. In this example, we assigned channel 11 to 23 in the new group (for data).

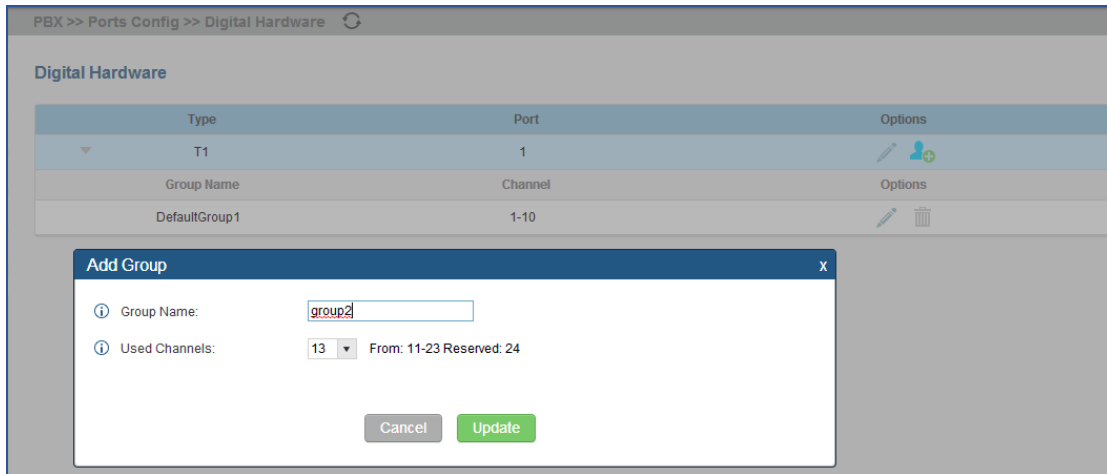

Figure 9: Add New Group 2

2.7. Click on “Update” to save the setting.

3. CONFIGURING DIGITAL PORT

3.1. Before configuring digital trunk, please check the physical connection of the T1/E1/J1 port as described in section **[1. CONNECTING]** to make sure the correct type of cable is used and properly connected.

3.2. Go to UCM6510 web UI->**PBX->Ports Config->Digital Hardware** page. Click on  to configure the digital port.

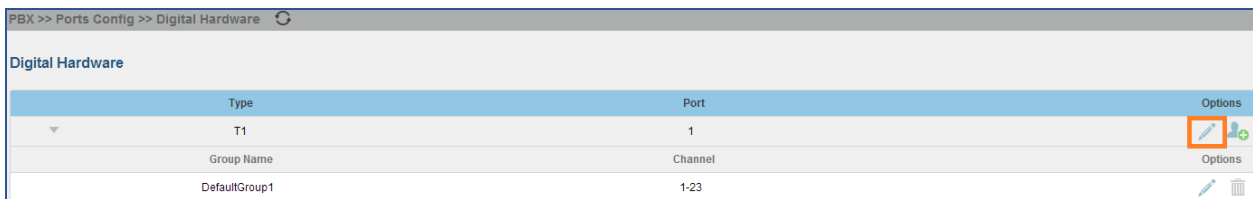





Type	Port	Options
T1	1	 
Group Name	Channel	Options
DefaultGroup1	1-23	 

Figure 10: Configure Digital Port 1

3.3. There are two tabs in the dialog to configure the digital port.

- **Basic Settings:** this includes span type and signaling configurations.

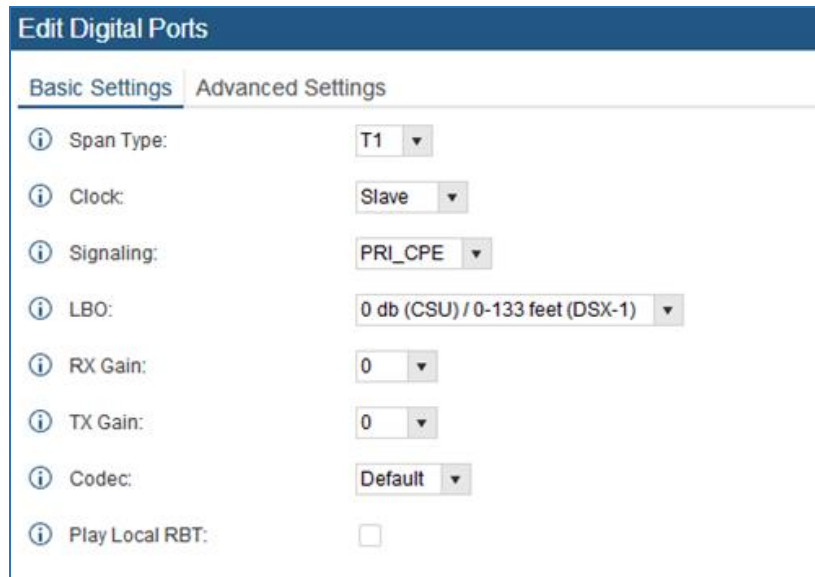

Edit Digital Ports

Basic Settings | Advanced Settings

Span Type: T1

Clock: Slave

Signaling: PRI_CPE

LBO: 0 db (CSU) / 0-133 feet (DSX-1)

RX Gain: 0

TX Gain: 0

Codec: Default

Play Local RBT:

Figure 11: Configure Digital Port – Basic Settings

- **Advanced Settings:** this includes switch type and dial plan configurations.

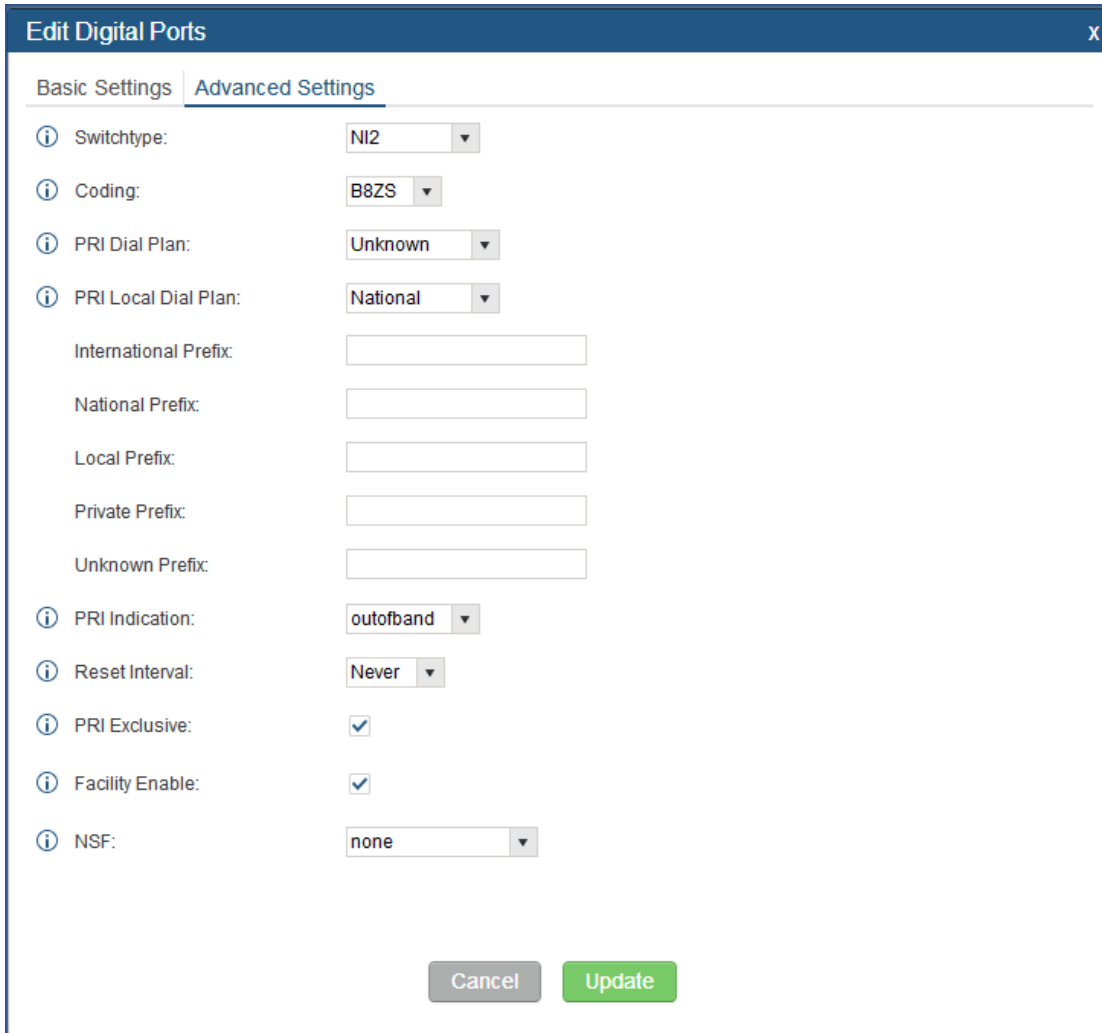

The screenshot shows a window titled "Edit Digital Ports" with a close button (X) in the top right corner. The window has two tabs: "Basic Settings" and "Advanced Settings", with "Advanced Settings" being the active tab. The settings are as follows:

Setting	Value
Switchtype:	NI2
Coding:	B8ZS
PRI Dial Plan:	Unknown
PRI Local Dial Plan:	National
International Prefix:	
National Prefix:	
Local Prefix:	
Private Prefix:	
Unknown Prefix:	
PRI Indication:	outofband
Reset Interval:	Never
PRI Exclusive:	<input checked="" type="checkbox"/>
Facility Enable:	<input checked="" type="checkbox"/>
NSF:	none

At the bottom of the dialog, there are two buttons: "Cancel" (grey) and "Update" (green).

Figure 12: Configure Digital Port – Advanced Settings

Click on “Update” to save the settings.

4. CONFIGURING DIGITAL TRUNK

4.1. Go to UCM6510 web UI->**PBX->Basic/Call Routes->Digital Trunks** page. Click on “Create New Digital Trunk”.

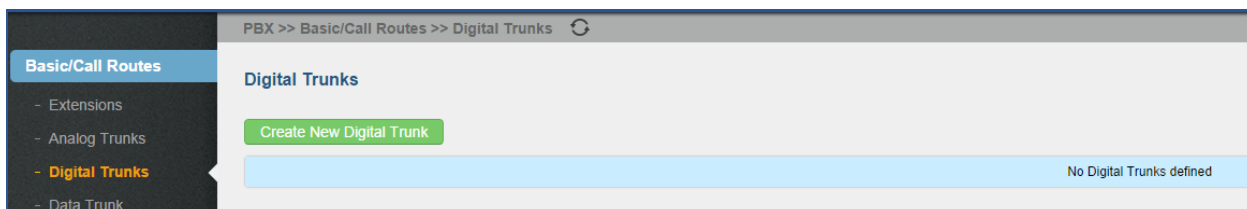

Figure 13: Create New Digital Trunk

4.2. Configure trunk name to identify this digital trunk. Select “Channel Group” to the default group for this trunk. Configure CallerID, Auto Record and Fax Detection options as needed.

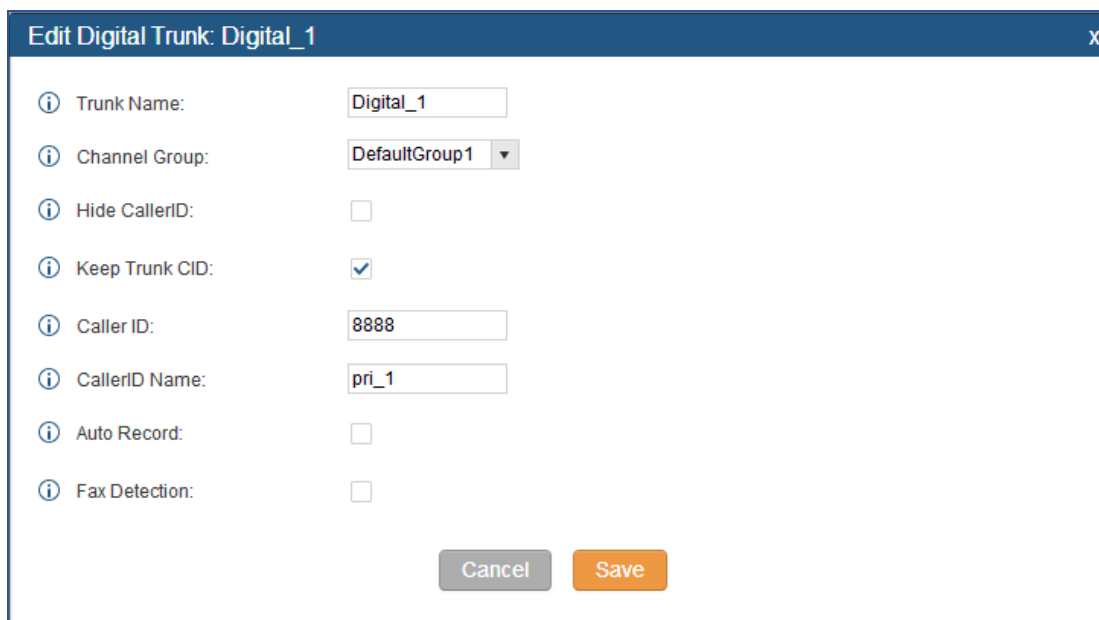

Figure 14: Configure Digital Trunk

4.3. Click on “Save” on the bottom of the dialog.

4.4. Click on “Apply Changes” on the upper right of the web page.

4.5. Go to web UI->**Status->PBX Status** page to check trunk status.

Status	Trunks	Type	Username	Port/Hostname/IP
Available	Digital_1	T1 (CPE)	-	Ports 1 (1-10)

Figure 15: Digital Trunk Status

If the status shows “Available”, the digital trunk is successfully configured and should work as expected now. If it shows “Unavailable” or “Error configured”, please check digital port configuration as described in section [\[3. CONFIGURING DIGITAL PORT\]](#), reconfigure, save and apply the changes again.

4.6. Configure inbound routes for this digital trunk under web UI->**PBX Status->Basic/Call Routes->Inbound Routes.**

4.7. Configure outbound routes for this digital trunk under web UI->**PBX Status->Basic/Call Routes->Outbound Routes.**

Until now the digital trunk has been completely configured and users should be able to make inbound and outbound calls.

5. CONFIGURING DATA TRUNK

5.1. Go to UCM6510 web UI->**PBX->Basic/Call Routes->Data Trunk** page. Click on  to edit the data trunk.

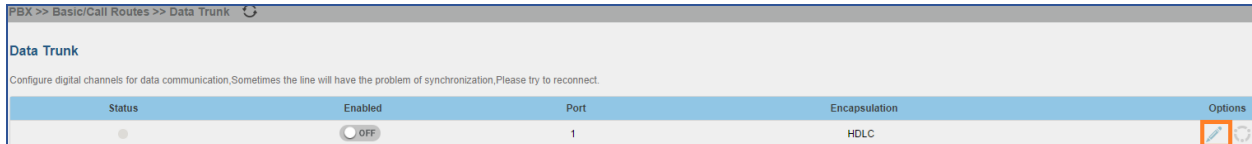

Figure 16: PBX->Basic/Call Routes->Data Trunk

5.2. Configure the data trunk in the Data Trunk dialog.
Select the group 2 we created in section **[2. CONFIGURING T1 CHANNELS]** as the channel group.
Users will not be able to select the group that has been already used.

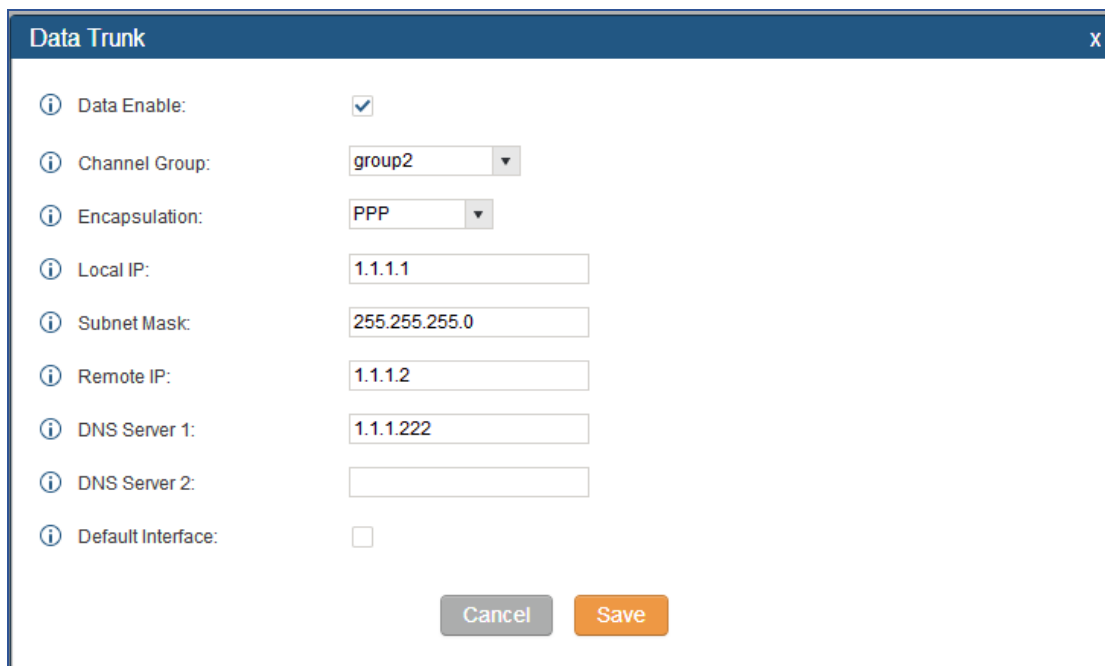



Figure 17: Configure Data Trunk

5.3. Click on “Save” on the bottom of the dialog.

5.4. Reboot the UCM6510 for the data trunk configuration to take effect.

5.5. Once the UCM6510 boots up, go to UCM6510 web UI->**PBX->Basic/Call Routes->Data Trunk** page

to check the status. If it shows , the data trunk is available to connect to Internet. Otherwise, please check the data trunk configuration or click on  to Reconnect.



Status	Enabled	Port	Encapsulation	Options
	<input checked="" type="checkbox"/>	1	PPP	 

Figure 18: Data Trunk Status

6. MONITORING DIGITAL PORT AND DIGITAL CHANNEL STATUS

So far the UCM6510 has both digital trunk and data trunk successfully configured. Users should be able to use it for phone calls and Internet connection. In this example, 10 channels (channel 1 to channel 10) are used for voice, 13 (channel 11 to channel 23) channels are used for data. While using the digital trunk and data trunk, users can monitor the connection status via UCM6510 web UI.

- Monitor interface status under web UI->**Status**->**PBX Status**.

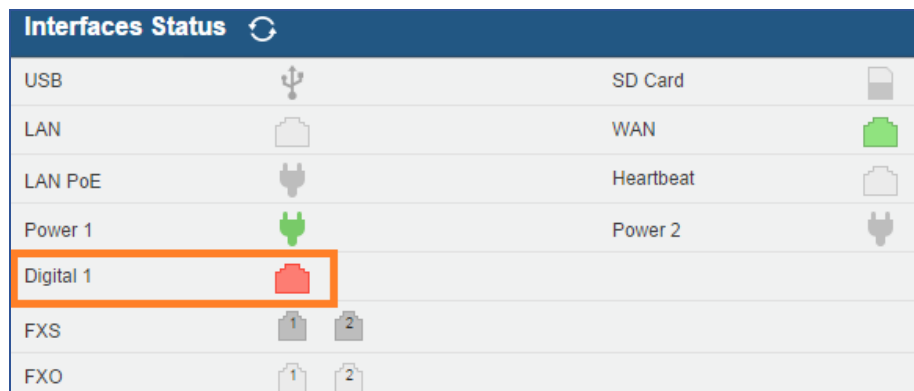







Figure 19: Interface Status

Table 1: Digital Port Status Indicators

Digital Port T1/E1/J1	
	Connected and working
	RED alarm: there is physical wiring problem, loss of connectivity, or a framing/line-coding mismatch with the remote switch.
	<p>YELLOW alarm: connected but the link is working only one-way. This means that the remote switch is not able to maintain sync with you, or is not receiving your transmission.</p> <p>The following example scenarios could trigger YELLOW alarm:</p> <ol style="list-style-type: none"> 1. The T1 port is connected with J1 connection. 2. Incorrect cable is used.

	3. When using E1, one end is using CRC4 while the other end is not.
	BLUE alarm: the port goes into BLUE alarm when it receives all unframed 1s on all timeslots from the remote switch. This is a special signal to indicate that the remote switch is having problem with its upstream connection.
	Cannot start up

- Monitor digital channel status under web UI->**Status->PBX Status**.

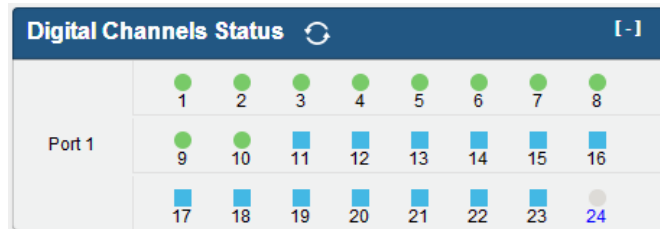







Figure 20: Digital Channels Status

Table 2: Digital Channel Status Indicators

Voice Channel	
	Not available
	Connected and in talking status; or incorrect configuration
	Connected and in idle status
	Connected and in ringing status
Data Channel	
	Always shows blue square
D Channel	
	Always shows grey with channel number in blue.

- Monitor data trunk status under web UI->**PBX->Basic/Call Routes->Data Trunk** page.

Data Trunk

Configure digital channels for data communication, Sometimes the line will have the problem of synchronization, Please try to reconnect.





Status	Enabled	Port	Encapsulation	Options
	<input checked="" type="checkbox"/>	1	PPP	 

Figure 21: Data Trunk Status

Table 3: Data Trunk Status Indicators

	Connected
	Not connected